

## Pressure sensors SPAU

**FESTO**



## Characteristics

### At a glance

#### Product description

The pressure sensor SPAU is suitable for monitoring compressed air and non-corrosive gases. The variant with display offers the option of reading the pressure and set values on-site. The pressure value is transmitted to the connected control system as a switching signal, as an analogue signal or via IO-Link.

The pressure sensor without display transmits the pressure value to the connected control system as an analogue signal. Display of the pressure and parameterisation of the sensor are provided centrally, e.g. via a display that is part of a machine control system. The pressure sensor can be parameterised using IO-Link as a tamper-proof pressure switch without display with up to two switching outputs.



### Areas of application

- Network monitoring (pressure present)
- Regulator monitoring (pressure in the setpoint range)
- Vacuum (part picked up)
- Leak test (pressure drop over time)
- Object detection (back pressure present)

### Product benefits

A mounting concept that is quick to mount and that is easy to implement in all installation situations. Female/male thread or push-in fitting QS – the perfect pneumatic adapter for every application.

#### Mounting:

- Threaded mounting
- H-rail mounting
- Front panel mounting
- Mounting bracket
- Wall mounting
- Adapter to MS4, MS6

#### Electronics:

- Maximum versatility and reduced warehousing thanks to switchable electrical outputs (PNP/NPN/N/C contact/N/O contact and current/voltage output)

## Characteristics

### Operation

Monitoring and setting of a pressure threshold, a pressure range or a pressure difference, using a teach-in function or by entering values.

#### Variants with display:

- Pressure indicator, pressure switching outputs and analogue value output from a device can be set on-site
- Quick commissioning of the pressure sensor thanks to straightforward menu navigation
- Display colour blue/red as visual feedback about the pressure of the medium
- Min./max. value memory for monitoring compressed air (display of rapid pressure peaks that are not visible to the human eye)
- Adjustable filter evens out the sensor signal generated by pressure peaks
- Scaling the analogue output to increase the signal dynamics
- Choice of pressure units: bar, MPa, PSI and more
- Offset compensation possible
- ECO function "Switch off display" available
- Optional security code can be freely chosen (4-digit code)
- All the settings for one sensor (master) can be transferred (replication) to other, identical sensors (device). This significantly shortens the commissioning time

#### Variants without display:

- Analogue value output and pressure switching outputs proportional to the pressure
- Switching output behaviour can be set on the machine display using IO-Link
- Other functions can be set using IO-Link

#### Variants with IO-Link:

- With and without display
- Serial communication integrated using IO-Link 1.1
- Analogue process value is provided digitally
- The sensor can be parameterised and maintained remotely at control level using an IO-Link master
- Automatic parameterisation following a sensor change means there is no need to re-parameterise or enter the settings again after changing the sensor

## Characteristics

### Device variants

#### Variants with display

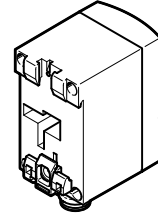
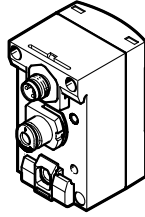
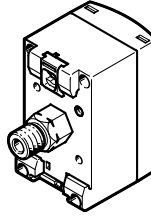
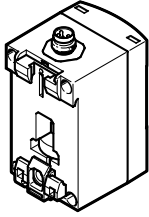
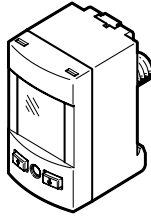
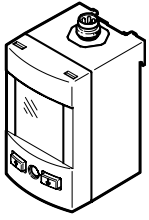

#### Variants with display for front panel mounting

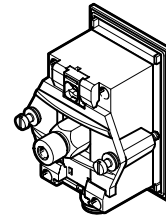
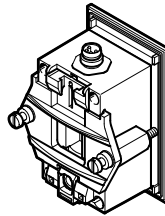
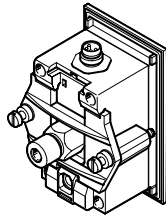
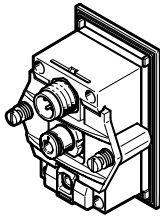
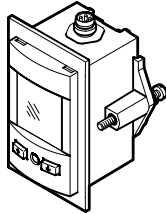
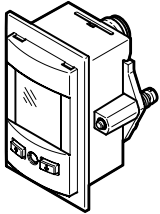

The connections shown are by way of example.

#### Variants with display and MS adapter

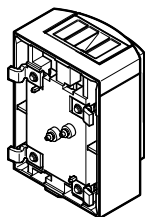
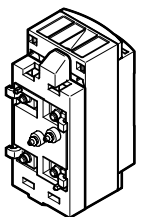
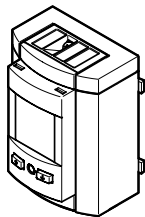
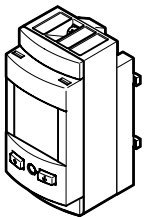

## Characteristics

### Device variants

Variants without display

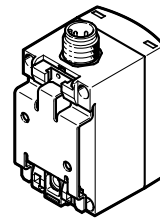
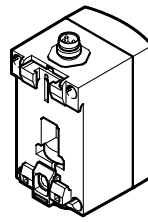
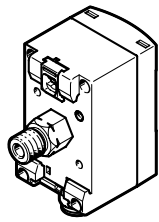
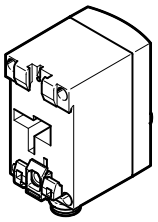
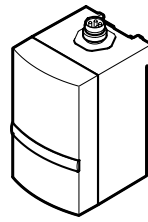
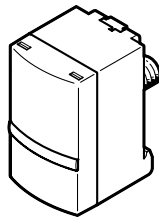
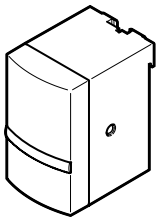

The connections shown are by way of example.

## Characteristics

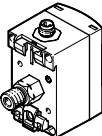
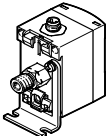
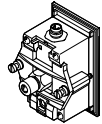
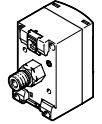
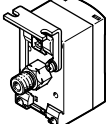
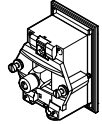
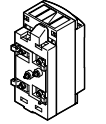
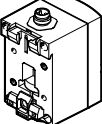
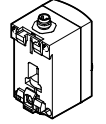
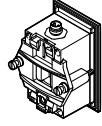
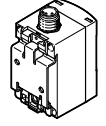
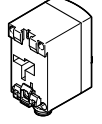
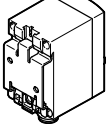
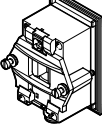
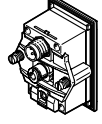
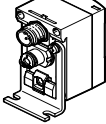
Housing variants	Types of mounting		Pneumatic connection
Pneumatic connection at rear Electrical connection on top	 Threaded mounting <sup>1)</sup>	 Mounting bracket (standing)	Male thread: G1/8, R1/8, N1/8, R1/4  Female thread: M5, M7
	 Front panel mounting		
Pneumatic connection at rear Electrical connection underneath	 Threaded mounting	 Mounting bracket (suspended)	Male thread: G1/8, R1/8, N1/8, R1/4  Female thread: M5, M7
	 Front panel mounting	 MS adapter	
Pneumatic connection underneath Electrical connection on top	 Threaded mounting	 H-rail	Female thread: G1/8, R1/8, N1/8, M7  Push-in connector: QS4, QS6, QS5/32
	 Front panel mounting	 Wall mounting	
Pneumatic connection underneath Electrical connection underneath	 H-rail	 Wall mounting	Push-in connector: QS4, QS5/32
	 Front panel mounting		
Pneumatic connection at rear Electrical connection at rear	 Front panel mounting	 Mounting bracket (standing)	Push-in connector: QS4, QS6, QS5/32

1) Threaded mounting with M5 female thread not recommended

## Peripherals overview

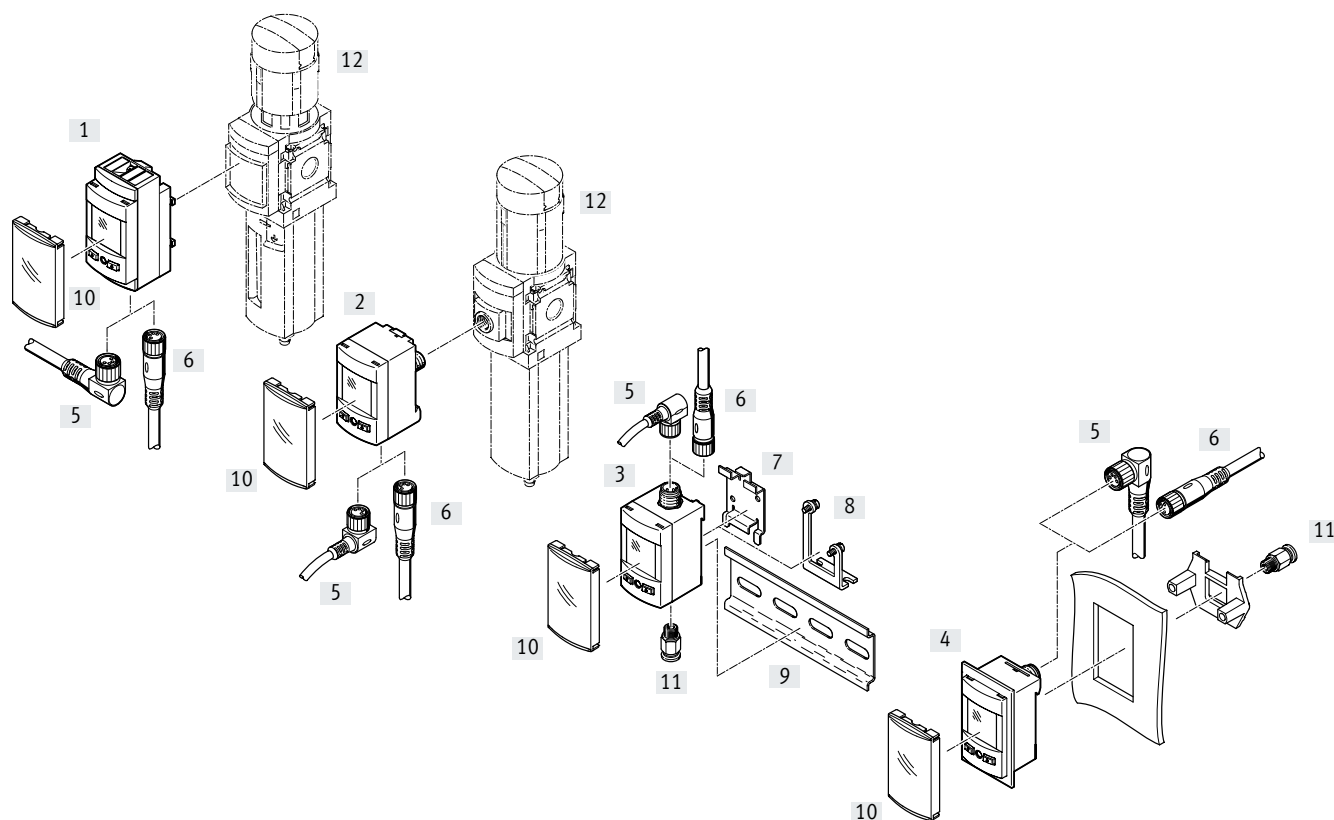

Accessories	→ Page/ Internet
[1] Pressure sensors SPAU, display variants for MS service unit components	9
[2] Pressure sensors SPAU, variants for threaded mounting	9
[3] Pressure sensors SPAU, variants for H-rail, wall mounting or mounting bracket	9
[4] Pressure sensors SPAU, variants for front panel mounting	9
[5] Connecting cable, angled plug socket M8x1	22
[6] Connecting cable, straight socket M8x1	22
[5] Connecting cable, angled plug socket M12x1	22

Accessories	→ Page/ Internet
[6] Connecting cable, straight socket M12x1	22
[7] Wall mounting SAMH-PU-W	20
[8] Mounting bracket SAMH-PU-A	20
[9] H-rail to DIN EN 60715	nrh
[10] Safety guard SACC-PU-G	21
[11] Pressure supply port	-
[12] Service unit component MS4, MS6	ms4, ms6

## Type codes

<b>001</b>	<b>Series</b>
<b>SPAU</b>	Pressure sensor

<b>002</b>	<b>Pressure measuring range</b>
<b>B2</b>	-1 ... 1 bar
<b>B11</b>	-1 ... 10 bar
<b>V025</b>	0 ... -0.25 bar
<b>V05</b>	0 ... -0.5 bar
<b>V1</b>	0 ... -1 bar
<b>P025</b>	0 ... 0.25 bar
<b>P05</b>	0 ... 0.5 bar
<b>P1</b>	0 ... 1 bar
<b>P2</b>	0 ... 2 bar
<b>P6</b>	0 ... 6 bar
<b>P10</b>	0 ... 10 bar
<b>P12</b>	0 ... 12 bar
<b>P16</b>	0 ... 16 bar

<b>003</b>	<b>Pressure inlet</b>
<b>R</b>	Relative pressure

<b>004</b>	<b>Type of mounting</b>
<b>T</b>	Threaded mounting
<b>A</b>	Mounting bracket
<b>F</b>	Front panel mounting
<b>H</b>	H-rail mounting
<b>W</b>	Wall mounting
<b>MS4</b>	Adapter MS4
<b>MS6</b>	Adapter MS6

<b>005</b>	<b>Pneumatic connection</b>
<b>G18</b>	G1/8
<b>M5</b>	M5
<b>M7</b>	M7
<b>N18</b>	1/8 NPT
<b>Q4</b>	Push-in connector 4 mm
<b>Q6</b>	Push-in connector 6 mm
<b>R14</b>	R1/4
<b>R18</b>	R1/8
<b>T532</b>	Push-in connector 5/32"
<b>F</b>	Flange/sub-base

<b>006</b>	<b>Thread type</b>
	None
<b>M</b>	Male
<b>F</b>	Female

<b>007</b>	<b>Outlet orientation</b>
	Rear
<b>D</b>	Underneath

<b>008</b>	<b>Display</b>
	None
<b>L</b>	LCD, backlit

<b>009</b>	<b>Electrical output 1</b>
<b>LK</b>	IO-Link®
<b>PNLK</b>	PNP or NPN or IO-Link®

<b>010</b>	<b>Electrical output 2</b>
<b>V</b>	0 ... 10 V
<b>B</b>	1 ... 5 V
<b>A</b>	4 ... 20 mA
<b>PNVBA</b>	PNP or NPN or 0 ... 10 V or 1 ... 5 V or 4 ... 20 mA

<b>011</b>	<b>Electrical connection</b>
<b>M8</b>	Plug M8
<b>M12</b>	Plug M12, A-coded

<b>012</b>	<b>Electrical outlet direction</b>
	Rear
<b>U</b>	Top
<b>D</b>	Underneath

<b>013</b>	<b>Electrical accessories</b>
	None
<b>2.5A</b>	Angled socket, cable 2.5 m
<b>2.5S</b>	Straight socket, cable 2.5 m
<b>5A</b>	Angled socket, cable 5 m
<b>5S</b>	Straight socket, cable 5 m

<b>014</b>	<b>Protective devices</b>
	None
<b>G</b>	Protective hood

<b>015</b>	<b>Certificate</b>
	None
<b>T</b>	Test report



## Data sheet

Display ... -L

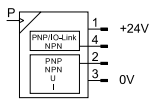

Variant without display  
Voltage output preset  
... -LK-V

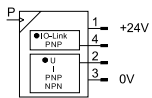

Variant without display  
Current output preset  
... -LK-A

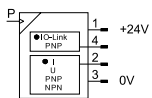

- - Voltage  
20 ... 30 V DC
- - Pressure measuring range  
-1 ... +16 bar
- - Temperature range  
0 ... +50°C



General technical data	
Certification	RCM compliance mark c UL us listed (OL)
CE marking (see declaration of conformity)	To EU EMC Directive To EU RoHS Directive
KC mark	KC EMC
UKCA marking (see declaration of conformity)	UK instructions for EMC UK RoHS instructions
Electrical connection	To EN 60947-5-2, plug 4-pin, round design
Mounting position	Any
Note on materials	RoHS-compliant

Inlet signal, measuring element		-B2	-B11	-V025	-V05	-V1	-P025	-P05
SPAU								
Measured variable		Relative pressure						
Measurement method		Piezoresistive pressure sensor						
Pressure measuring range start value [bar]		-1		0				
Pressure measuring range end value [bar]		1	10	-0.25	-0.5	-1	0.25	0.5
Overload range [bar]		5	15	1	2	5	1	2
Operating medium		Compressed air to ISO 8573-1:2010 [7:4:4] Inert gases						
Note on operating/pilot medium		Lubricated operation possible						
Temperature of medium [°C]		0 ... +50						
Ambient temperature [°C]		0 ... +50						

## Data sheet

SPAU	-P1	-P2	-P6	-P10	-P12	-P16
Measured variable	Relative pressure					
Measurement method	Piezoresistive pressure sensor					
Pressure measuring range start value [bar]	0					
Pressure measuring range end value [bar]	1	2	6	10	12	16
Overload range [bar]	5	6	15	15	15	20
Operating medium	Compressed air to ISO 8573-1:2010 [7:4:4] Inert gases					
Note on operating/pilot medium	Lubricated operation possible					
Temperature of medium [°C]	0 ... +50					
Ambient temperature [°C]	0 ... +50					

### Signal processing

Resolution ADC [bit]	12
----------------------	----

Output, general	-B2	-B11	-V025	-V05	-V1	-P025	-P05
Accuracy FS [%]	±1.5						
Repetition accuracy [%FS]	±0.3						
Temperature coefficient [%FS/K]	±0.05						

Output, general	-P1	-P2	-P6	-P10	-P12	-P16
Accuracy FS [%]	±1.5					±2
Repetition accuracy [%FS]	±0.3					
Temperature coefficient [%FS/K]	±0.05					

### Switching output

Switching output	-PNLK	-LK
Switching output	2x PNP or 2x NPN, switchable	2x PNP <sup>1)</sup>
Switching function	Freely programmable	
Switching element function	N/C or N/O contact, switchable	

1) Second PNP output can only be activated using IO-Link

### Analogue output

Analogue output	-PNLK-PNVBA	-LK-A	-LK-V	-LK-B
[V]	0 ... 10	– <sup>1)</sup>	0 ... 10	– <sup>1)</sup>
[V]	1 ... 5	– <sup>2)</sup>	– <sup>2)</sup>	1 ... 5
[mA]	4 ... 20	4 ... 20	– <sup>3)</sup>	– <sup>3)</sup>
Rise time [ms]	3			
Max. output current [mA]	100			
Max. load resistance of current output [Ω]	500			
Min. load resistance of voltage output [kΩ]	10			

- 1) 0 ... 10 V analogue output can only be activated using IO-Link  
 2) 1 ... 5 V analogue output can only be activated using IO-Link  
 3) 4 ... 20 mA analogue output can only be activated using IO-Link

## Data sheet

Output, additional data	
Short circuit current rating	Yes
Overload protection	Present

IO-Link device to IEC 61131-9	
Protocol	IO-Link
IO-Link	
Protocol version	Device V 1.1
Profile	Smart sensor profile
Function classes	Binary data channel (BDC)
	Diagnostics
	Identification
	Process data variable (PDV)
	Teach channel
Communication mode	COM2 (38.4 kBaud)
SIO-mode support	Yes
Port class	A
Process data width OUT	0 bytes
Process data width IN	2 bytes
Process data content IN	14 bit PDV (pressure measurement value)
	2 bit BDC (pressure monitoring)
Minimum cycle time	[ms] 3
Data storage required	[Kbyte] 0.5

Electronics	
Operating voltage range DC	[V] 20 ... 30
Reverse polarity protection	For all electrical connections

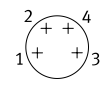
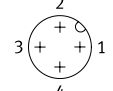
Pin allocation to EN 60947-5-2				
Plug, 4-pin				
M8x1	M12x1	Pin	Wire colour	Allocation
		1	Brown	Operating voltage +24 V DC
		3	Blue	Operating voltage 0 V
		4	Black	Switching output (C/Q...)
		2	White	Switching output or analogue output

## Data sheet

Display/operation SPAU	-L-PNLK	-LK
Display type	Backlit LCD	LED
Displayable units	bar	-
	inchH2O	-
	inchHg	-
	kgf/cm <sup>2</sup>	-
	kPa	-
	mmHg	-
	MPa	-
Setting options	IO-Link	-
	Teach-in	-
	Via display and pushbuttons	-
Protection against tampering	IO-Link	-
	PIN code	-
Threshold value setting range [%]	0 ... 100	
Hysteresis setting range [%]	0 ... 90	
Immission/emission	-T/H/W/A	-F/MS4/MS6
Degree of protection	IP67, IP65	IP65
Corrosion resistance class CRC <sup>1)</sup>	2	

1) Corrosion resistance class CRC 2 to Festo standard FN 940070

Moderate corrosion stress. Indoor applications in which condensation can occur. External visible parts with primarily decorative surface requirements which are in direct contact with a normal industrial environment.

## Data sheet

### Dimensions

Download CAD data → [www.festo.com](http://www.festo.com)

SPAU-...-F-...-L-PNLK-...

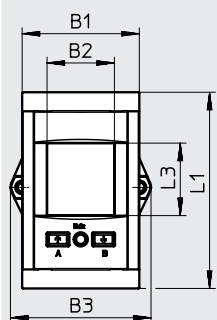

SPAU-...-L-PNLK-...

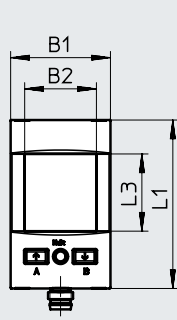

SPAU-...-LK-...

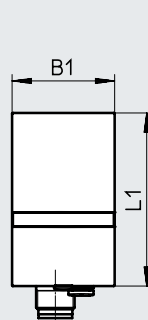

Type	B1	B2	B3	L1	L3
SPAU-...-F-...-L-PNLK-...	40	23	48	67	24.8
SPAU-...-L-PNLK-...	32	-	-	54	-
SPAU-...-LK-...	-	-	-	-	-

### Service unit dimensions

Download CAD data → [www.festo.com](http://www.festo.com)

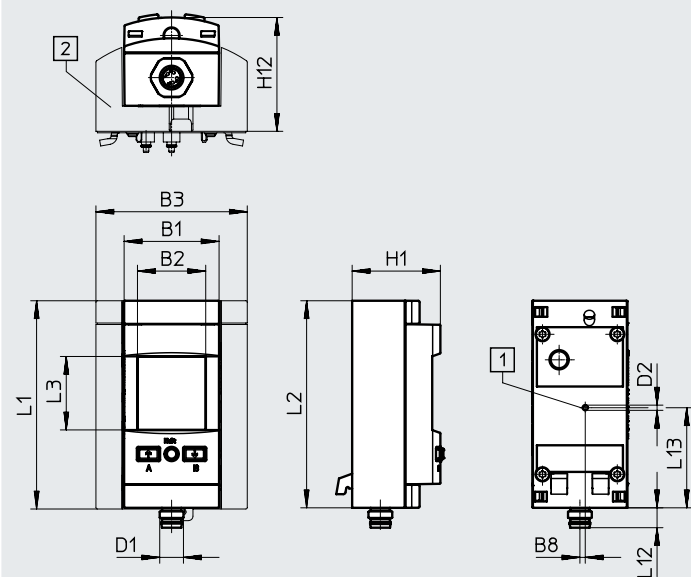

- [1] Pressure supply port
- [2] Adapter for MS4, MS6 series (is enclosed for the customer to fit)

Type	B1	B2	B3	B8	D1	D2	H1	H12	L1	L2	L3	L12	L13
SPAU-P10R-MS-...-L-...-M8	32	23	-	1.8	M8x1	1.8	29.8	-	-	69.8	24.8	6.7	33.8
SPAU-P10R-MS-...-L-...-M12	32	23	-	1.8	M12x1	1.8	29.8	-	-	69.8	24.8	6.7	33.8
SPAU-P10R-MS4-F-L-...-M8D	32	23	32	1.8	M8x1	1.8	29.8	~38.3	70.2	69.8	24.8	6.7	33.8
SPAU-P10R-MS6-F-L-...-M8D	32	23	51	1.8	M8x1	1.8	29.8	~38.3	70.2	69.8	24.8	10	33.8
SPAU-P10R-MS4-F-L-...-M12D	32	23	32	1.8	M12x1	1.8	29.8	~38.3	70.2	69.8	24.8	6.7	33.8
SPAU-P10R-MS6-F-L-...-M12D	32	23	51	1.8	M12x1	1.8	29.8	~38.3	70.2	69.8	24.8	10	33.8

Data sheet

Dimensions of connections

Download CAD data → [www.festo.com](http://www.festo.com)

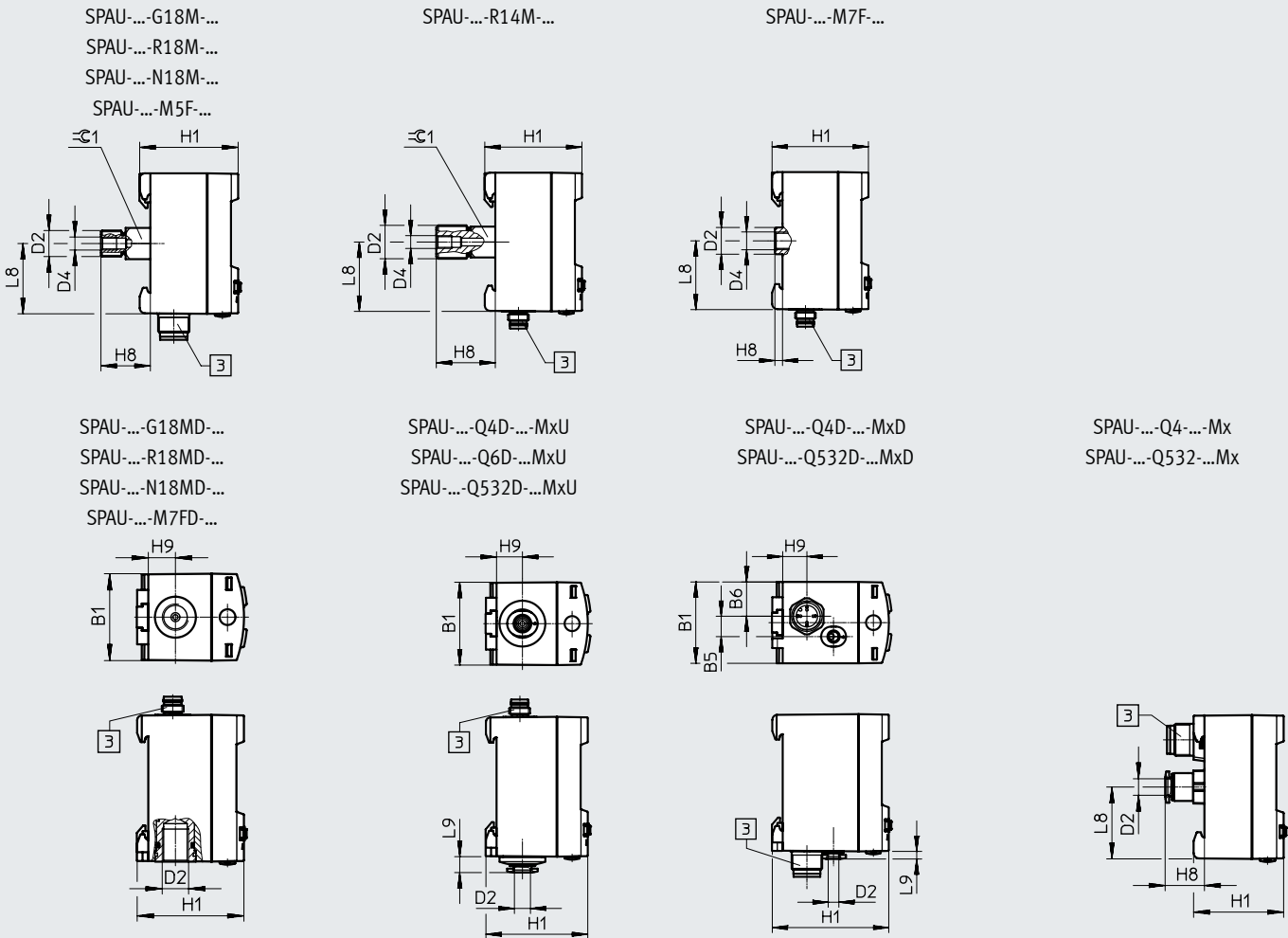

[3] Connections  
 SPAU-...-M12... M12, 4-pin  
 SPAU-...-M8... M8, 4-pin

Type	B1	B5	B6	D2	Thread length		Length of thread engagement	D4	H1	H8	H9	L8	L9	⌀C1		
					Male (M)	Female (F)										
SPAU-...-G18M-...-MxD	-	-	-	G1/8	8	-	Until stop	M5	37.9	19	-	27	-	12		
SPAU-...-R18M-...-MxD				R1/8			Min. 6.5									
SPAU-...-N18M-...-MxD				1/8NPT			Min. 6.9									
SPAU-...-M5F-...-MxD				M5	-	6	Until stop									
SPAU-...-R14M-...-MxD				R1/4	12	-	Min. 9.7									
SPAU-...-M7F-...-MxD	M7	-	8	Until stop	M7	3	-									
SPAU-...-G18FD-...-MxU	32			G1/8				-	39.4	-	10	-				
SPAU-...-R18FD-...-MxU				R1/8											8	Min. 6.5
SPAU-...-N18FD-...-MxU				1/8NPT											Min. 6.9	
SPAU-...-M7FD-...-MxU				M7											Until stop	
SPAU-...-Q4D-...-MxU				QS4	-	-	-							6.1		
SPAU-...-Q6D-...-MxU				QS6												
SPAU-...-T532D-...-MxU				T5/32												
SPAU-...-Q4D-...-MxD		8	13.5	QS4				45.9			9.5		3			
SPAU-...-T532D-...-MxD				T5/32												
SPAU-...-Q4-...-Mx	-	-	-	QS4				33.9	14.8	-	27	-				
SPAU-...-Q6-...-Mx				QS6												
SPAU-...-T532-...-Mx				T5/32												

Data sheet

Dimensions for front panel mounting

Download CAD data → [www.festo.com](http://www.festo.com)

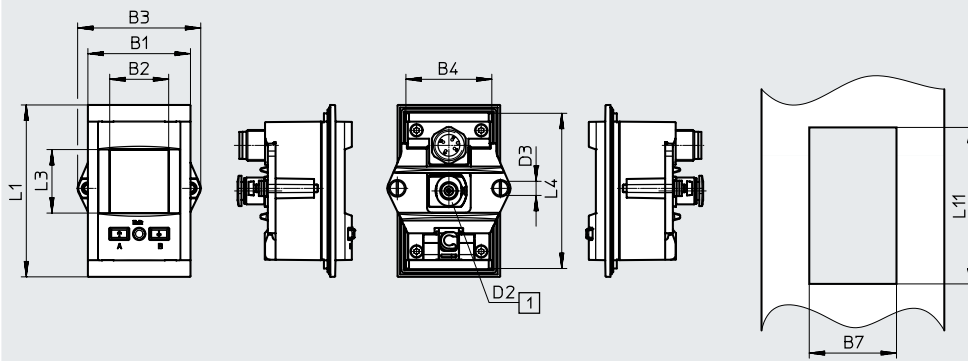

[1] Pressure supply port

Recess for front panel

SPAU-...-F...-MxD

SPAU-...-F...-MxU

SPAU-...-F...FD...-MxU

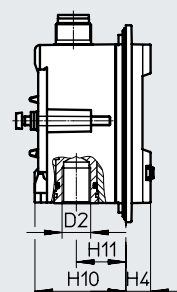
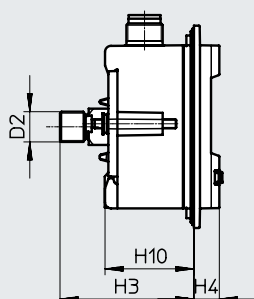
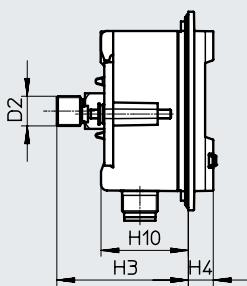

SPAU-...-F-Q...D...-MxU  
SPAU-...-F-T532D...-MxU





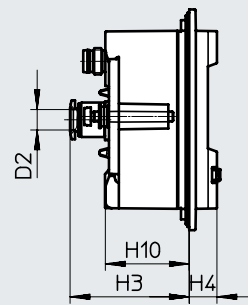
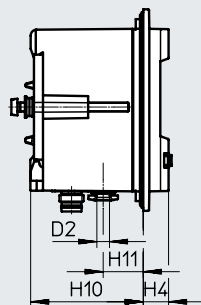
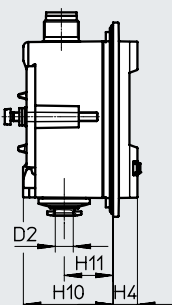

SPAU-...-F-Q4D...-MxD  
SPAU-...-F-T532D...-MxD

SPAU-...-F-Q...-Mx  
SPAU-...-F-T532...-Mx











Type	B1	B2	B3	B4	B7 ±0.3	D2	D3	H3	H4	H10	H11	L1	L3	L4	L11 ±0.3		
SPAU-...-F...18M...-MxD	40	23	48	33.5	34	-	M3	44.4	8.4	29.5	-	67	24.8	60.5	61		
SPAU-...-F-R14M...-MxD						R1/8		48.4									
SPAU-...-F-M7F...-MxD						M7		28.4									
SPAU-...-F-M5F...-MxD						M5		-									
SPAU-...-F...18M...-MxU						-		44.4									
SPAU-...-F-R14M...-MxU						R1/4		48.4									
SPAU-...-F-M7F...-MxU						M7		28.4									
SPAU-...-F-M5F...-MxU						M5		-									
SPAU-...-F...18FD...-MxU						-		31								16.9	
SPAU-...-F-M7FD...-MxU						M7											
SPAU-...-F-Q...D...-MxU						-											
SPAU-...-F-T532D...-MxU						T5/32		37.5								13.4	
SPAU-...-F-Q4D...-MxD						QS4											
SPAU-...-F-T532D...-MxD						T5/32		36.1								25.5	
SPAU-...-F-Q...-Mx						-											-
SPAU-...-F-T532...-Mx						T5/32											

Data sheet

Ordering data – Variants with display								
	Type of mounting	Pneumatic connection	Outlet orientation	Electrical connection	Outlet orientation	Product weight	Part no.	Type
<b>Pressure measuring range –1 ... +1</b>								
	Thread	R1/8	Rear	M8x1	Underneath	80	<b>8001207</b>	<b>SPAU-B2R-T-R18M-L-PNLK-PNVBA-M8D</b>
	H-rail	G1/8	Underneath	M8x1	Top	70	<b>8001219</b>	<b>SPAU-B2R-H-G18FD-L-PNLK-PNVBA-M8U</b>
<b>Pressure measuring range 0 ... -1</b>								
	H-rail	G1/8	Underneath	M8x1	Top	70	<b>8001223</b>	<b>SPAU-V1R-H-G18FD-L-PNLK-PNVBA-M8U</b>
		QS-4	Underneath	M8x1	Underneath	65	<b>8001213</b>	<b>SPAU-V1R-H-Q4D-L-PNLK-PNVBA-M8D</b>
		QS-5/32	Underneath	M8x1	Underneath	65	<b>8001217</b>	<b>SPAU-V1R-H-T532D-L-PNLK-PNVBA-M8D</b>
		QS-5/32	Underneath	M12x1	Underneath	65	<b>8001218</b>	<b>SPAU-V1R-H-T532D-L-PNLK-PNVBA-M12D</b>
	Wall/surface bracket	G1/8	Underneath	M8x1	Top	70	<b>8001235</b>	<b>SPAU-V1R-W-G18FD-L-PNLK-PNVBA-M8U</b>
		G1/8	Underneath	M12x1	Top	70	<b>8001234</b>	<b>SPAU-V1R-W-G18FD-L-PNLK-PNVBA-M12U</b>
		QS-4	Underneath	M8x1	Underneath	65	<b>8001239</b>	<b>SPAU-V1R-W-Q4D-L-PNLK-PNVBA-M8D</b>
		QS-4	Underneath	M12x1	Underneath	65	<b>8001214</b>	<b>SPAU-V1R-H-Q4D-L-PNLK-PNVBA-M12D</b>
		QS-4	Underneath	M12x1	Underneath	65	<b>8001238</b>	<b>SPAU-V1R-W-Q4D-L-PNLK-PNVBA-M12D</b>
	Front panel mounting	QS-4	Rear	M12x1	Rear	70	<b>8001227</b>	<b>SPAU-V1R-F-Q4-L-PNLK-PNVBA-M12</b>
		QS-6	Rear	M12x1	Rear	70	<b>8001228</b>	<b>SPAU-V1R-F-Q6-L-PNLK-PNVBA-M12</b>
		QS-5/32	Rear	M12x1	Rear	70	<b>8001229</b>	<b>SPAU-V1R-F-T532-L-PNLK-PNVBA-M12</b>
<b>Pressure measuring range 0 ... 2</b>								
	Wall/surface bracket	G1/8	Underneath	M8x1	Top	70	<b>8001232</b>	<b>SPAU-P2R-W-G18FD-L-PNLK-PNVBA-M8U</b>
<b>Pressure measuring range 0 ... 6</b>								
	Wall/surface bracket	G1/8	Underneath	M8x1	Top	70	<b>8001233</b>	<b>SPAU-P6R-W-G18FD-L-PNLK-PNVBA-M8U</b>



## Data sheet

Ordering data – Variants with display								
	Type of mounting	Pneumatic connection	Outlet orientation	Electrical connection	Outlet orientation	Product weight	Part no.	Type
<b>Pressure measuring range 0 ... 10</b>								
	Thread	G1/8	Rear	M8x1	Underneath	80	8001201	SPAU-P10R-T-G18M-L-PNLK-PNVBA-M8D
		G1/8	Rear	M12x1	Underneath	80	8001204	SPAU-P10R-T-G18M-L-PNLK-PNVBA-M12D
		R1/8	Rear	M8x1	Underneath	80	8001203	SPAU-P10R-T-R18M-L-PNLK-PNVBA-M8D
		R1/8	Rear	M12x1	Underneath	80	8001206	SPAU-P10R-T-R18M-L-PNLK-PNVBA-M12D
		R1/4	Rear	M8x1	Underneath	80	8001209	SPAU-P10R-T-R14M-L-PNLK-PNVBA-M8D
		R1/4	Rear	M12x1	Underneath	80	8001208	SPAU-P10R-T-R14M-L-PNLK-PNVBA-M12D
		1/8-27NPT	Rear	M8x1	Underneath	80	8001202	SPAU-P10R-T-N18M-L-PNLK-PNVBA-M8D
1/8-27NPT	Rear	M12x1	Underneath	80	8001205	SPAU-P10R-T-N18M-L-PNLK-PNVBA-M12D		
	H-rail	G1/8	Underneath	M8x1	Top	70	8001221	SPAU-P10R-H-G18FD-L-PNLK-PNVBA-M8U
		G1/8	Underneath	M12x1	Top	70	8001220	SPAU-P10R-H-G18FD-L-PNLK-PNVBA-M12U
		QS-4	Underneath	M8x1	Underneath	65	8001211	SPAU-P10R-H-Q4D-L-PNLK-PNVBA-M8D
		QS-4	Underneath	M12x1	Underneath	65	8001212	SPAU-P10R-H-Q4D-L-PNLK-PNVBA-M12D
		QS-5/32	Underneath	M8x1	Underneath	65	8001215	SPAU-P10R-H-T532D-L-PNLK-PNVBA-M8D
		QS-5/32	Underneath	M12x1	Underneath	65	8001216	SPAU-P10R-H-T532D-L-PNLK-PNVBA-M12D
	Wall/surface bracket	G1/8	Underneath	M8x1	Top	70	8001231	SPAU-P10R-W-G18FD-L-PNLK-PNVBA-M8U
		G1/8	Underneath	M12x1	Top	70	8001230	SPAU-P10R-W-G18FD-L-PNLK-PNVBA-M12U
		QS-4	Underneath	M8x1	Underneath	70	8001237	SPAU-P10R-W-Q4D-L-PNLK-PNVBA-M8D
		QS-4	Underneath	M12x1	Underneath	70	8001236	SPAU-P10R-W-Q4D-L-PNLK-PNVBA-M12D
	Front panel mounting	QS-4	Rear	M12x1	Rear	70	8001224	SPAU-P10R-F-Q4-L-PNLK-PNVBA-M12
		QS-6	Rear	M12x1	Rear	70	8001225	SPAU-P10R-F-Q6-L-PNLK-PNVBA-M12
		QS-5/32	Rear	M12x1	Rear	70	8001226	SPAU-P10R-F-T532-L-PNLK-PNVBA-M12
	Service unit	Flange MS4	Rear	M8x1	Underneath	80	8035302	SPAU-P10R-MS4-F-L-PNLK-PNVBA-M8D
		Flange MS4	Rear	M12x1	Underneath	80	8035304	SPAU-P10R-MS4-F-L-PNLK-PNVBA-M12D
		Flange MS6	Rear	M8x1	Underneath	80	8035303	SPAU-P10R-MS6-F-L-PNLK-PNVBA-M8D
		Flange MS6	Rear	M12x1	Underneath	80	8074906	SPAU-P10R-MS6-F-L-PNLK-PNVBA-M12D
<b>Pressure measuring range 0 ... 16</b>								
	Thread	R1/4	Rear	M8x1	Underneath	80	8001210	SPAU-P16R-T-R14M-L-PNLK-PNVBA-M8D
	H-rail	G1/8	Underneath	M12x1	Top	70	8001222	SPAU-P16R-H-G18FD-L-PNLK-PNVBA-M12U
<b>Ordering data – Variants without display</b>								
	Type of mounting	Pneumatic connection	Outlet orientation	Electrical connection	Analogue output	Product weight	Part no.	Type
<b>Pressure measuring range 0 ... -1</b>								
	Thread	G1/8	Rear	M12x1	0 ... 10 V	80	8003347	SPAU-V1R-T-G18M-LK-V-M12D
			Rear		4 ... 20 mA		8003348	SPAU-V1R-T-G18M-LK-A-M12D
	H-rail	QS-4	Underneath	M12x1	0 ... 10 V	65	8003351	SPAU-V1R-H-Q4D-LK-V-M12D
			Underneath		4 ... 20 mA		8003352	SPAU-V1R-H-Q4D-LK-A-M12D
<b>Pressure measuring range 0 ... 10</b>								
	Thread	G1/8	Rear	M12x1	0 ... 10 V	80	8003345	SPAU-P10R-T-G18M-LK-V-M12D
			Rear		4 ... 20 mA		8003346	SPAU-P10R-T-G18M-LK-A-M12D
	H-rail	QS-4	Underneath	M12x1	0 ... 10 V	65	8003349	SPAU-P10R-H-Q4D-LK-V-M12D
			Underneath		4 ... 20 mA		8003350	SPAU-P10R-H-Q4D-LK-A-M12D

## Ordering data – Modular product system

Ordering table		Conditions	Code	Enter code
Pressure sensor	SPAU			
Module no.	<b>8001200</b>			
Product type	SPAU series U		<b>SPAU</b>	SPAU
Pressure measuring range	-1 ... 1 bar		<b>-B2</b>	
	-1 ... 10 bar		<b>-B11</b>	
	0 ... -0.25 bar		<b>-V025</b>	
	0 ... -0.5 bar		<b>-V05</b>	
	0 ... -1 bar		<b>-V1</b>	
	0 ... 0.25 bar		<b>-P025</b>	
	0 ... 0.5 bar		<b>-P05</b>	
	0 ... 1 bar		<b>-P1</b>	
	0 ... 2 bar		<b>-P2</b>	
	0 ... 6 bar		<b>-P6</b>	
	0 ... 10 bar		<b>-P10</b>	
	0 ... 12 bar		<b>-P12</b>	
	0 ... 16 bar		<b>-P16</b>	
Pressure inlet	Relative pressure		<b>R</b>	R
Type of mounting	Threaded mounting		<b>-T</b>	
	Mounting bracket		<b>-A</b>	
	Front panel mounting		<b>-F</b>	
	H-rail mounting		<b>-H</b>	
	Wall mounting		<b>-W</b>	
	Adapter MS4		<b>-MS4</b>	
	Adapter MS6		<b>-MS6</b>	
Pneumatic connection	G1/8		<b>-G18</b>	
	M5	[1]	<b>-M5</b>	
	M7		<b>-M7</b>	
	1/8 NPT		<b>-N18</b>	
	Push-in connector 4 mm	[2]	<b>-Q4</b>	
	Push-in connector 6 mm	[2]	<b>-Q6</b>	
	R1/4	[15]	<b>-R14</b>	
	R1/8		<b>-R18</b>	
	Push-in connector 5/32	[2]	<b>-T532</b>	
Flange	[17]	<b>-F</b>		
Thread type	None			
	Male thread	[3] [4]	<b>M</b>	
	Female thread	[3] [5]	<b>F</b>	
Outlet orientation	Rear	[6]		
	Underneath	[7]	<b>D</b>	
Display	Without			
	LCD, backlit	[8]	<b>-L</b>	

- [1] M5 Only with type of mounting A, F.  
 [2] Q4, Q6, T532 Not with type of mounting T.  
 Not with pressure measuring range P16.  
 [3] M, F Mandatory information in combination with pneumatic connection G18, N18, R18, R14, M7, M5.  
 [4] M Not with type of mounting H, W, MS4, MS6.  
 Not with pneumatic connection Q4, Q6, T532, M7, M5.  
 [5] F Not with type of mounting A if pneumatic connection G18, R18, N18.  
 Not with type of mounting MS4, MS6.  
 Not with pneumatic connection Q4, Q6, Q532.  
 [6] Not with type of mounting W, H.  
 Not with thread type F if pneumatic connection G18, R18, N18.  
 [7] D Not with pneumatic connection M5.  
 Not with type of mounting A, MS4, MS6.  
 Not with thread type M.  
 [8] L Mandatory information in combination with type of mounting F, MS4, MS6.

## Ordering data – Modular product system

Ordering table		Conditions	Code	Enter code
Pressure sensor	SPAU			
Electrical output 1	IO-Link	[9]	<b>-LK</b>	
	PNP or NPN or IO-Link	[10]	<b>-PNLK</b>	
Electrical output 2	0 ... 10 V	[9]	<b>-V</b>	
	1 ... 5 V	[9]	<b>-B</b>	
	4 ... 20 mA	[9]	<b>-A</b>	
	PNP or NPN or 0 ... 10 V or 1 ... 5 V or 4 ... 20 mA	[10]	<b>-PNVBA</b>	
Electrical connection	Plug M8		<b>-M8</b>	
	M12 plug, A-coded		<b>-M12</b>	
Electrical outlet orientation	Rear	[11]		
	Underneath	[12]	<b>D</b>	
	Top	[13]	<b>U</b>	
Electrical accessories	Without accessories			
	Angled plug socket, cable 2.5 m		<b>+2.5A</b>	
	Straight socket, cable 2.5 m		<b>+2.5S</b>	
	Angled plug socket, cable 5 m		<b>+5A</b>	
	Straight socket, cable 5 m		<b>+5S</b>	
Protective devices	Without			
	Safety guard	[16]	<b>G</b>	
Certificate	Without			
	Test report		<b>T</b>	

- [9] LK, V, B, A Not with display L.  
 [10] PNLK, PNVBA Not without display.  
 [11] Only with type of mounting A, F.  
 Not with pneumatic connection G18, N18, R18, M7, M5.  
 Not with outlet orientation D, U.  
 Only with thread type "without".
- [12] D Mandatory information in combination with type of mounting MS4, MS6.  
 Only with outlet orientation D if pneumatic connection Q4 or T532 selected.  
 Not with outlet at rear if pneumatic connection Q4, Q6, T532.
- [13] U Only with outlet orientation U if pneumatic connection Q4 or T532 selected.  
 Not with outlet at rear if pneumatic connection Q4, Q6, T532.
- [15] R14 Only with thread type M.  
 Outlet at rear only.  
 Not with type of mounting W, H.  
 Not with electrical outlet at rear.
- [16] G Only with display L.
- [17] F Only with type of mounting MS4, MS6.

## Accessories

### Mounting bracket SAMH-PU-A

Type of mounting: via through-hole and screw

Material:  
High-alloy stainless steel

Note on materials: RoHS-compliant

Only for variants with: pneumatic connection with outlet at rear

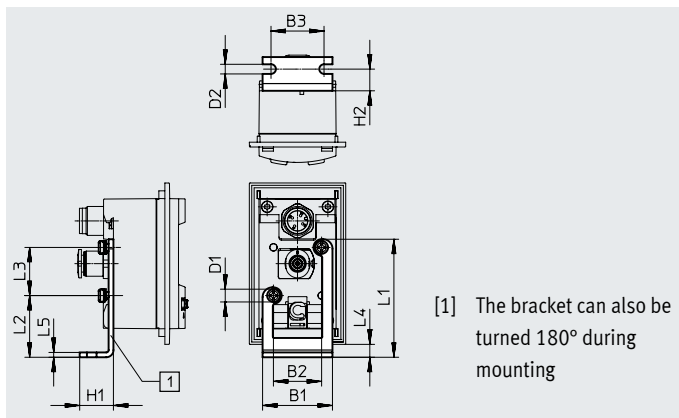

#### Ordering data

Type	B1	B2	B3	D1	D2	H1	H2	L1	L2	L3	L4	L5	CRC <sup>1)</sup>	Part no.	Type
SAMH-PU-A	29	20	22	M3x8	4	14	9	49	25.6	20	8.6	2	2	8003354	SAMH-PU-A

1) Corrosion resistance class 2 to Festo standard 940 070

Components subject to moderate corrosion stress. External visible parts with primarily decorative surface requirements which are in direct contact with a normal industrial environment or media such as coolants or lubricating agents.

### Wall mounting SAMH-PU-W

Type of mounting: via through-hole

Material:  
High-alloy stainless steel

Note on materials: RoHS-compliant

Only for variants with: pneumatic connection with outlet underneath

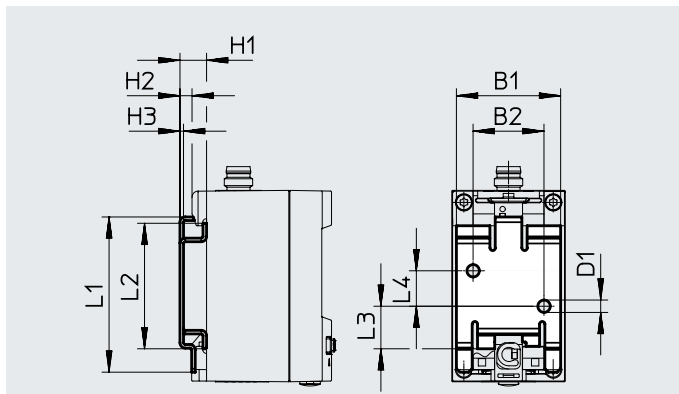

#### Dimensions and ordering data

Type	B1	B2	D1	H1	H2	H3	L1	L2	L3	L4	CRC <sup>1)</sup>	Part no.	Type
SAMH-PU-W	29.4	20	3.5	7.5	3.4	1	43.8	35.4	12	10	2	8003355	SAMH-PU-W

1) Corrosion resistance class CRC 2 to Festo standard FN 940070

Moderate corrosion stress. Indoor applications in which condensation can occur. External visible parts with primarily decorative surface requirements which are in direct contact with a normal industrial environment.

## Accessories – Ordering data

### Safety guard SACC-PU-G

to protect the display and control elements

Material: PA

Note on materials:  
RoHS-compliant

Only for variants with: display

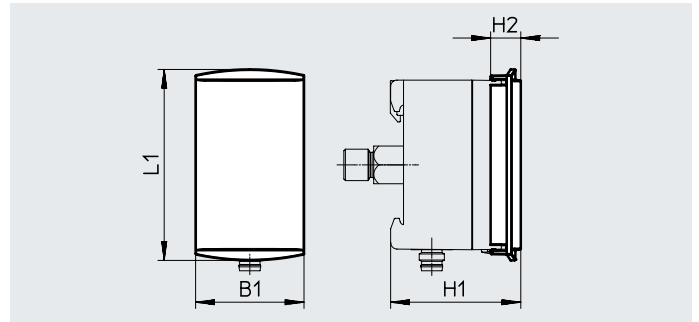



Dimensions and ordering data		B1	H1	H2	L1	CRC <sup>1)</sup>	Part no.	Type
SACC-PU-G	SPAU- ... R-T- ...	34.5	41.6	9.6	60.8	2	8003353	SACC-PU-G
	SPAU- ... R-H- ... -D-L- ...		49.6					
	SPAU- ... R-H- ... -FD-L- ...		43.6					
	SPAU- ... R-F- ...		37.6					
	SPAU- ... R-W- ... -D-L- ...		43.6					
	SPAU- ... R-W- ... -FD-L- ...		49.6					

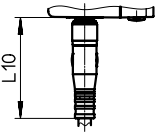
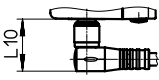
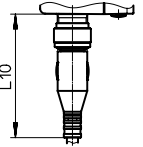
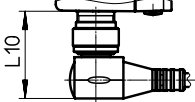

1) Corrosion resistance class CRC 2 to Festo standard FN 940070

Moderate corrosion stress. Indoor applications in which condensation can occur. External visible parts with primarily decorative surface requirements which are in direct contact with a normal industrial environment.

## Accessories

Connecting cables				L10
		M8	Straight socket	36.3
			Angled plug socket	18.7
		M12	Straight socket	50
			Angled plug socket	28.5

Ordering data					Data sheets → Internet: nebu
	Number of wires	Cable length [m]	Part no.	Type	
<b>M8x1, straight socket</b>					
	4	2.5	541342	NEBU-M8G4-K-2.5-LE4	
		5	541343	NEBU-M8G4-K-5-LE4	
<b>M8x1, angled plug socket</b>					
	4	2.5	541344	NEBU-M8W4-K-2.5-LE4	
		5	541345	NEBU-M8W4-K-5-LE4	

Ordering data					Data sheets → Internet: nebu
	Number of wires	Cable length [m]	Part no.	Type	
<b>M12x1, straight socket</b>					
	4	2.5	550326	NEBU-M12G5-K-2.5-LE4	
		5	541328	NEBU-M12G5-K-5-LE4	
<b>M12x1, angled plug socket</b>					
	4	2.5	550325	NEBU-M12W5-K-2.5-LE4	
		5	541329	NEBU-M12W5-K-5-LE4	